



Technology Day 2016

# **Expand into higher margin businesses**

Yves Serra / 21.09.2016



# A leading industrial solutions provider **+GF+**

We offer three times premium expertise and service to match our customers' needs:

## GF Piping Systems

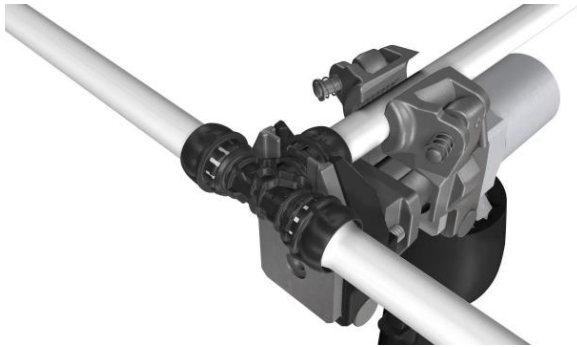

## GF Automotive



## GF Machining Solutions



**39%**

CHF 1 417 million

**36%**

CHF 1 321 million

**25%**

CHF 902 million

**Total sales in 2015: CHF 3 640 million**

# Partnering with our customers ...

## Utility



Gaz de France



Stadt Zürich  
Entsorgung + Recycling



Your natural gas company

## Building Technology



Hotel Adlon  
Kempinski

BERLIN



## Industry

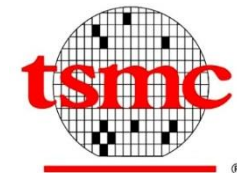
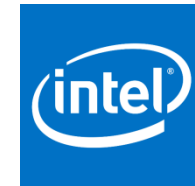

**... to conserve water and avoid contamination ...**



**... through safe and secure piping systems.**

# Partnering with car/truck manufacturers worldwide ...

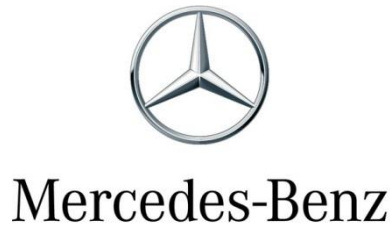

**... to address the emission challenge ...**

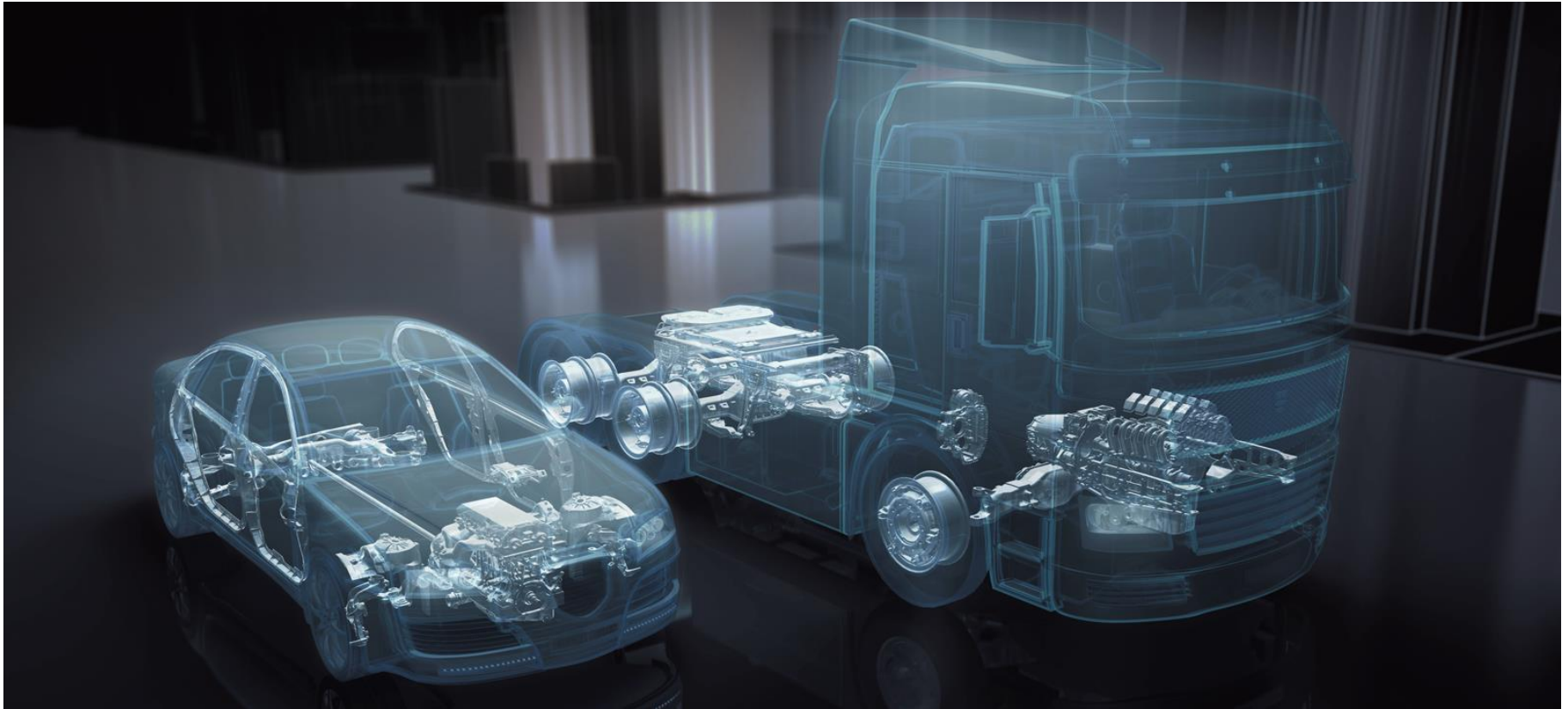

**... through weight reduction.**

# We offer our customers ...

## ICT



CATCHER

JABIL

## Medical



## Aviation



Honeywell



# ... solutions to their automated precision needs





# Profitable growth

1. Optimize productivity in Europe / expand in growth markets

2. Expand into higher margin businesses

3. Drive sales proficiency and innovation excellence

## Objectives 2020



ROIC 18-22%



ROS 8-9%



Annual Growth 3-5%

# Widen presence in growth markets ...

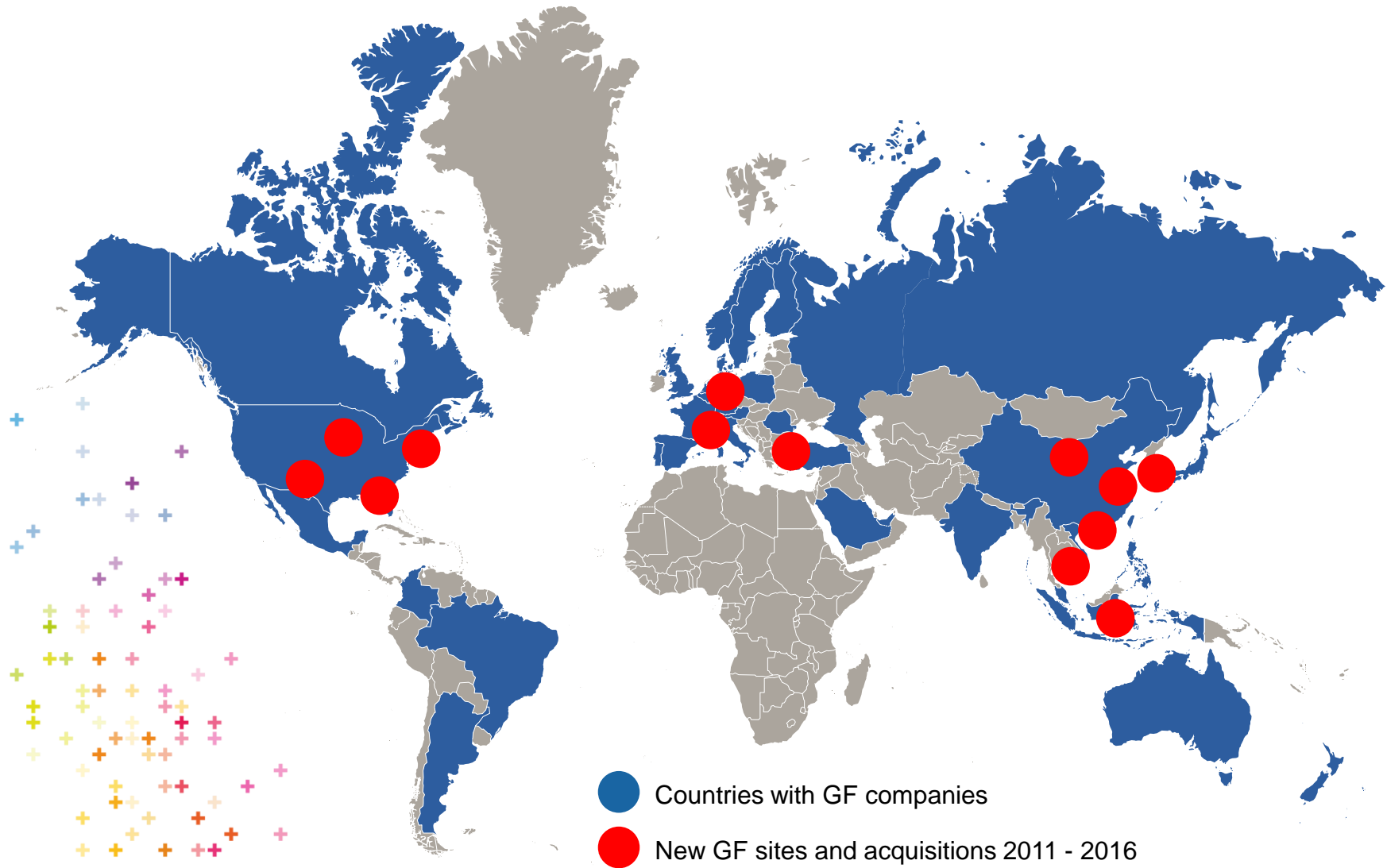

# ...including through acquisitions



Eurapipe (Indonesia) acquisition

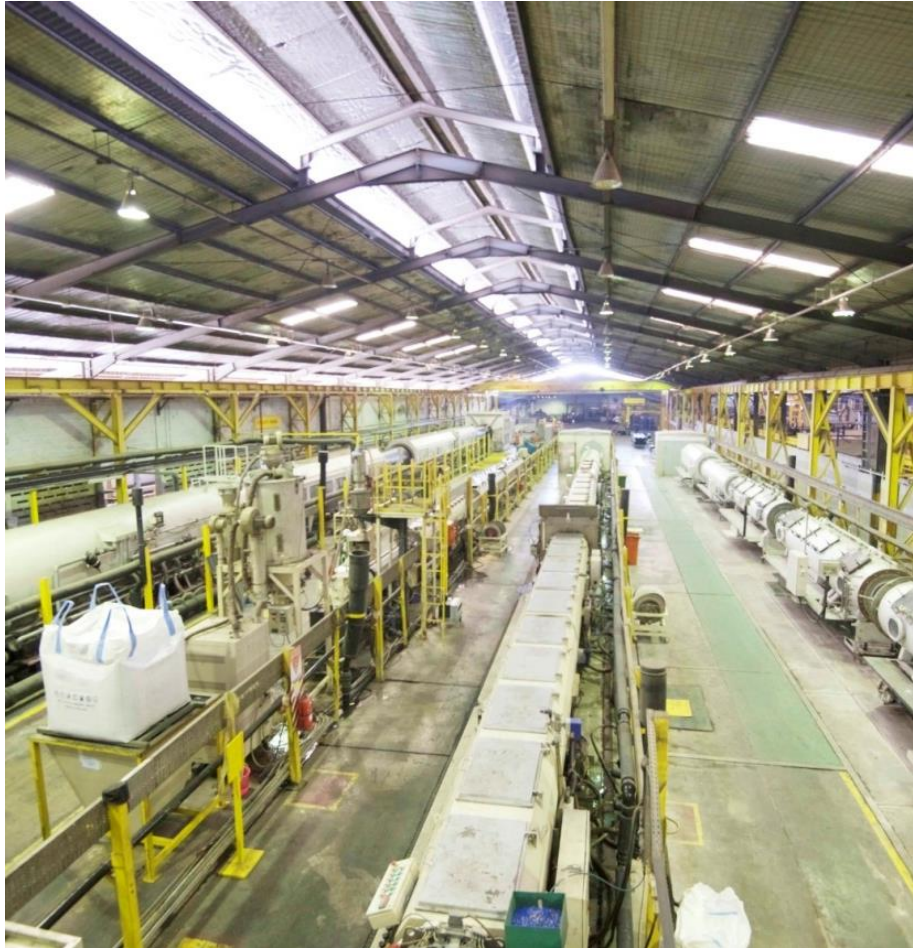

Langfang  
(China)  
acquisition

# Expand into higher margin businesses – Focus TechDay 2016

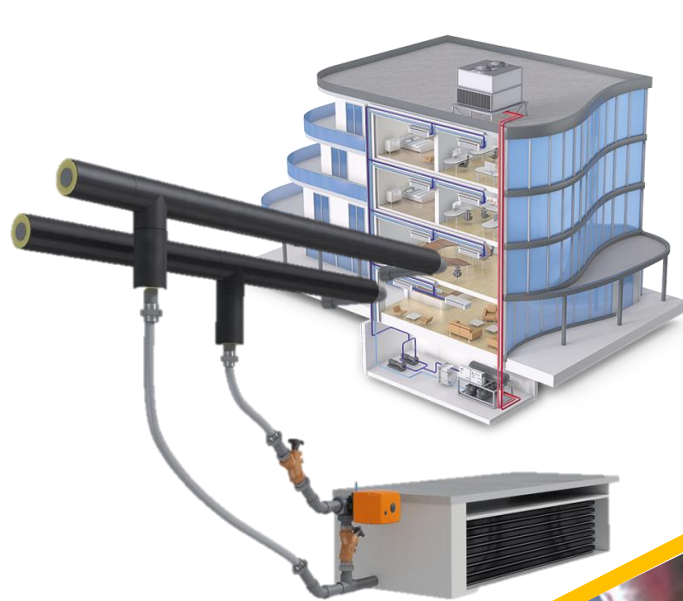

**Air-conditioning**



**E-Mobility**



**Laser applications**



# Drive innovation excellence in partnership with our customers

